



# WIRELESS E-PAPER REFERENCE DESIGN

## Abstract

Multifunctional development kit showcasing MiWi mesh radio, Bluetooth, USB connectivity, and Li-Ion battery management. User interface accomplished with ePaper display.

Don Wyman

Don.wyman@electronicdesignsolutions.net

# E-Paper Display Demo Kit

---

## Overview

*This demo kit provides a hand held low power battery operated device promoting Pervasive Displays Inc. 1.44 inch electronic paper display. This demo kit also highlights Microchip's PIC24 family microprocessor with USB functionality, wireless connectivity, and graphical user interface. Linear Technology provides battery management and system power. The external connector exposes 16 processor pins for custom development. This kit incorporates a low power, sunlight readable high resolution display with a 180 degree viewing angle. This kit also provides connectivity through Microchips low power wireless module, Bluetooth low energy module, USB and asynchronous serial communication. Depending on local wireless requirements, selecting an appropriate demo kit will allow the user operate in the approved 863-870MHz, 902-928 MHz or 2.4 GHz spectrum. The USB provides host connectivity to external hardware memory devices and printers. USB device mode is also supported. Lithium-ion rechargeable battery management is achieved by using Linear Technology charger and coulomb counting gas gauge solution. There are three push buttons for navigating the graphical user interface. Also included is a low power 32 kHz clock for real time clock calendar functionality. This demo kit is feature rich and provides the developer a great project head start.*

*Central to the design is the PIC24FJ256GB106 and implements the USB, file I/O, graphics and MiWi software libraries. The firmware utilizes Microchips latest application library v2015\_05\_15. The design utilizes a state-machine cooperative multitasking approach to handle the graphic display interface, file I/O, USB events and radio communications.*

## Demo

*The demo kit showcases the interaction of Microchip's graphic library with Pervasive Displays 1.44 inch EPD. The four demonstrations include: graphing received radio strength indication, file creation and capturing data to a thumb drive, battery charge management and simple Bluetooth message loop back.*

*The three key pads allows menu navigation; the top right button navigates the highlight selection to the right while the top left button navigates the highlight to the left and the bottom middle button is the select button. These keys are soft keys and are reassigned according to the menu context. Holding down the select key for 5 seconds powers down the device. Powering down the Pan Coordinator will cause a broadcast message 'power down' to all End devices. Likewise, to wake up the device press the select button.*

*The Receive Signal Strength Indication (RSSI) demonstration illustrates both the graphical display and some of the wireless capabilities. In order to run this demo, the PAN Coordinator requires at least one end device in the network. Next, the user navigates through the Utilities page and selects RSSI. Every 10 seconds the Pan Coordinator requests from the end device to respond with the RSSI value and then updates the strip chart. The end device calculates the RSSI value and transmits back to the PAN Coordinator.*

*The USB thumb drive demo illustrates Microchips solution to USB and file I/O. After navigating through the Utilities page and selecting "USB demo" the user is prompted with "attach a USB memory". The demo proceeds to create a file demo\_date.xls with the current date stamp. The file is written to every 10 seconds until the user presses the 'ok' button. At this point, the user can remove the thumb drive and validate the creation of a comma separated excel file on a PC.*

*The battery charge management demonstration updates the battery charge status. The Battery charge status demo screen will show current battery charge and will either increment or decrement the value depending if the external charger is connected. For an accurate account of the battery charge status, the battery must complete one charge cycle and not be disconnected from the board.*

*If the battery is disconnected the charge status register will report a default mid-range value. This demo also indicates if the battery is charging, complete charge, over temperature or battery does not accept charge.*

*The Bluetooth loop back demonstration interacts with a BLE enabled smart device. The RN4020 operates using the Microchip low-energy data profile and establishes a connection to a smart device. Using Microchips MLDP application, messages sent to the device will be echoed back and displayed on the incoming screen.*

## **Hardware Features**

- *Low power*
- *1.4 inch ePaper display*
- *Feature rich PIC24*
- *Wireless connectivity, MiWi, Bluetooth Low Energy*
- *Host and device USB connectivity*
- *Lithium Ion Battery management*
- *Preprogrammed unique identification memory*
- *Power efficient power switching regulators*
- *User input keys*
- *Status led*
- *Optional MikroElektronika break out board*

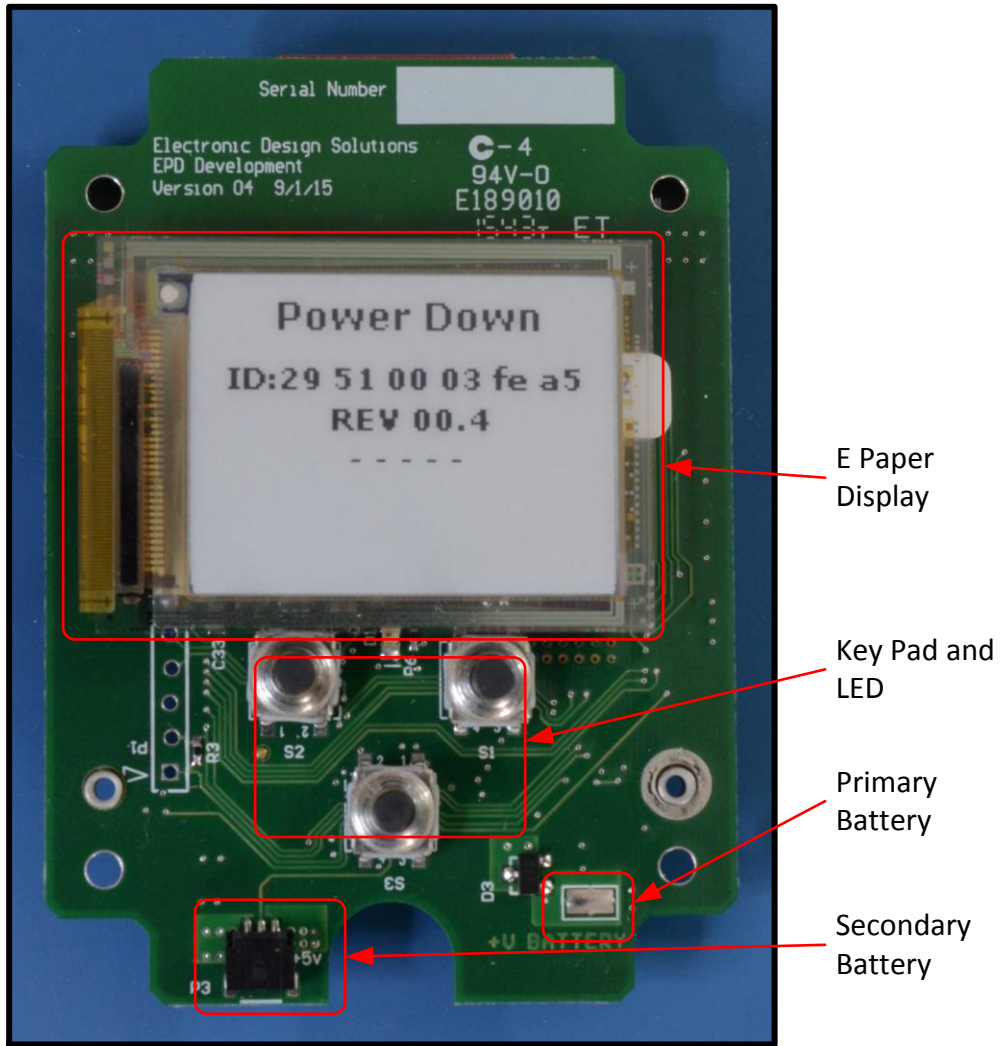

Figure 1 Top Side view



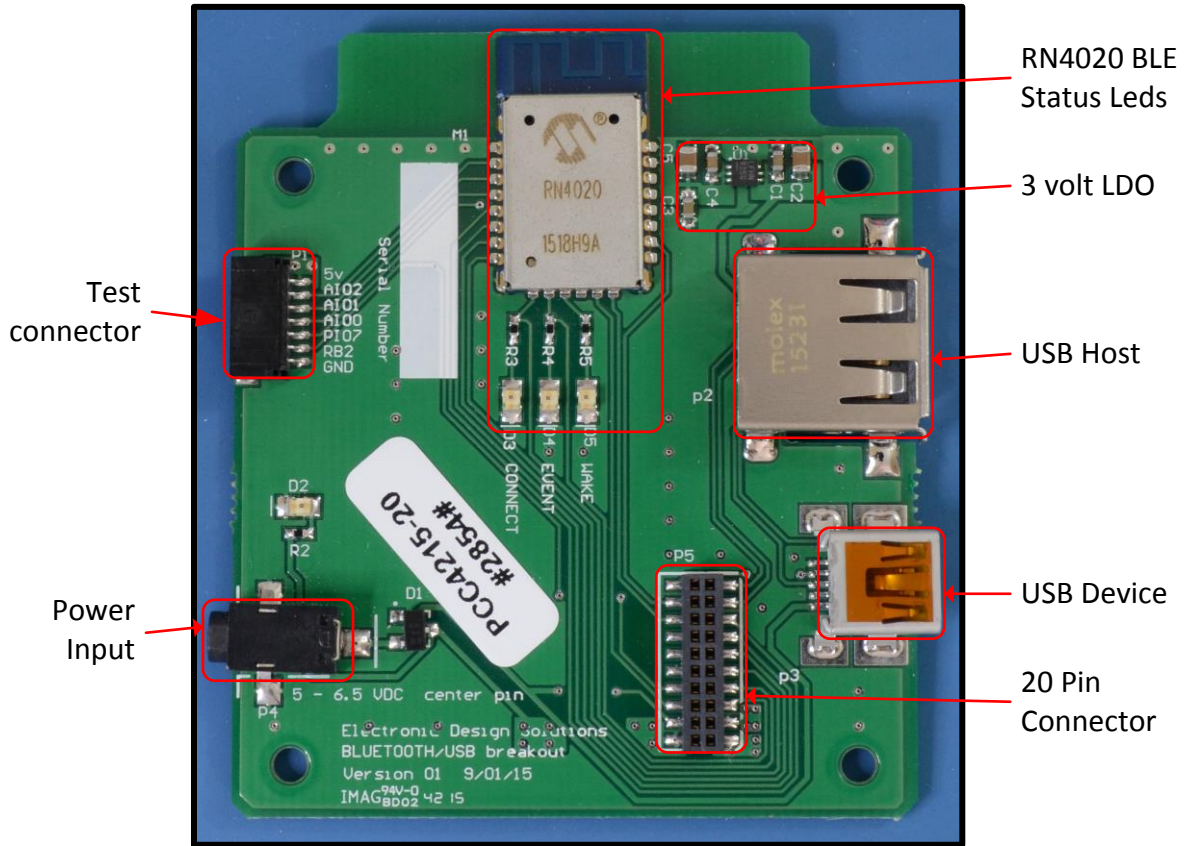

Figure 3. Bluetooth/USB option

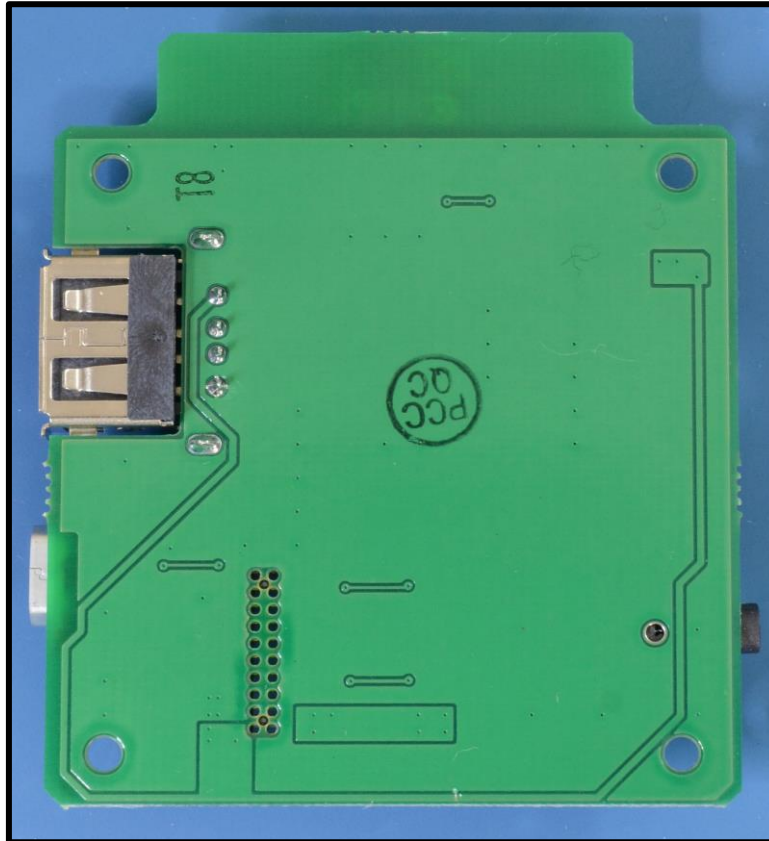

Figure 4. Bluetooth bottom side





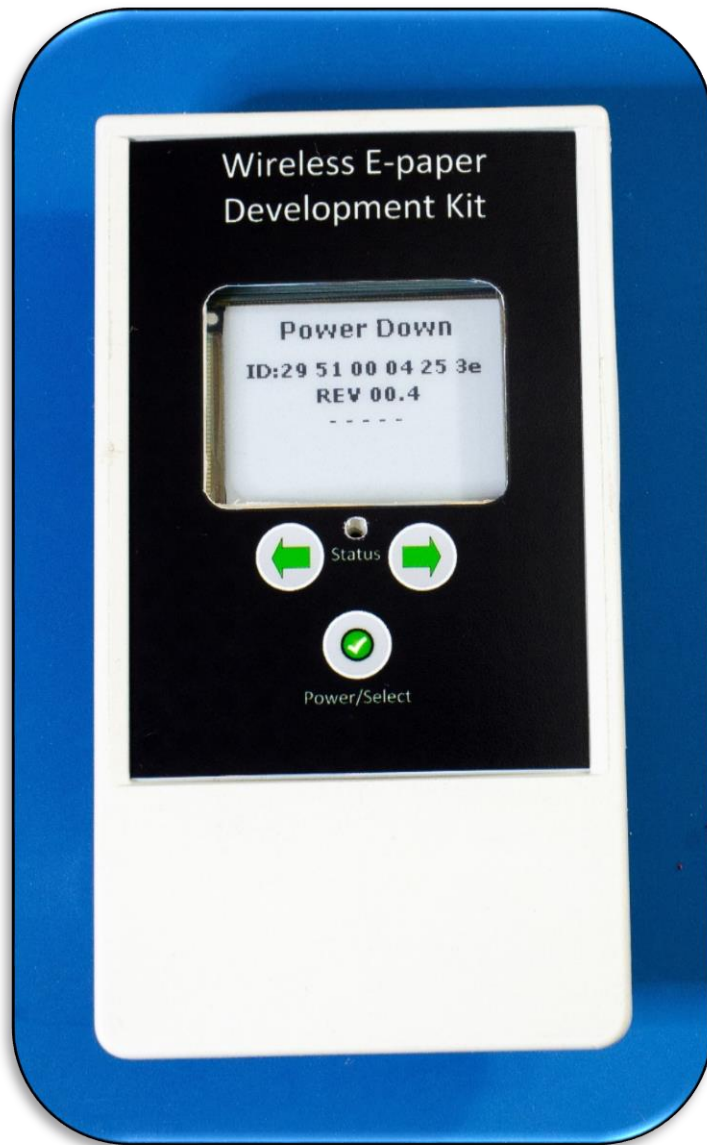

Figure 6. Front view with overlay

## Hardware Specification

### Connector pin definitions

There are four connectors on the board. Connector P1 allows for programming and code development. Connector P2 connects internal, external power, and user defined input/output. The red text in the following tables indicate configurable pins. The pins indicated in red text can be remapped to I2C, PWM, timers and counters. There are also three SPI pins that are shared with the memory devices. Also included are 2 10 bit analog channels. Connector P3 is a connection to a secondary 200 mAh Li-Ion battery. The last connection are two surface mount pads to connect to a primary battery power source. These two pads are marked 'gnd' and '+V BATTERY'

Table 5 shows allocation of the microprocessor pins and the net names are referenced on the schematics.

Table 1. P1, Debug connection		
PIN	DESCRIPTION	NOTES
1	MCLR	
2	3.3V	
3	GND	
4	PGD	
5	PGC	

Table 2. P3, Secondary Battery connection		
PIN	DESCRIPTION	NOTES
1	BATTERY POSITIVE	100 mA charger LIMIT
2	BATTERY TEMPERATURE	Not used
3	BATTERY GROUND	return

Table 3. P2, External I/O assignment		
PIN	DESCRIPTION	NOTES
1	POWER OUTPUT	5 V
2	POWER INPUT	1.8-5.5 V
3	GROUND	
4	SENSE	USB POWER SENSE
5	C1IND/RP21/PMA5/CN8/RG6	USER DEFINED
6	PGEC3/AN5/C1INA/VBUSON/RP18/CN7/RB5	USER DEFINED
7	C1INC/RP26/PMA4/CN9/RG7	USER DEFINED
8	AN2/C2INB/VMIO/RP13/CN4/RB2	USER DEFINED
9	PMD4/CN62/RE4	USER DEFINED
10	SPI SDI	SHARED WITH MEMORY
11	PMD3/CN61/RE3	USER DEFINED
12	SPI SDO	SHARED WITH MEMORY
13	C2IND/RP19/PMA3/CN10/RG8	USER DEFINED
14	SPI SCK	SHARED WITH MEMORY
15	RP27/PMA2/C2INC/CN11/RG9	USER DEFINED
16	SDA2/RP10/PMA9/CN17/RF4	USER DEFINED
17	D+/RG2	USER DEFINED
18	SCL2/RP17/PMA8/CN18/RF5	USER DEFINED
19	D-/RG3	USER DEFINED
20	RP16/USBID/CN71/RF3	USER DEFINED

Table 4. Power Requirements 900 mhz			
operating conditions	min	max	units
power charging circuit			
voltage	4.5	6	volts
current	50	140	ma
power not charging			
voltage	2.4	6	volts
current	6	35	ma

Table 5. Power Requirements 2.4Ghz			
operating conditions	min	max	units
power charging circuit			
voltage	4.5	6	volts
current	50	140	ma
power not charging			
voltage	2.4	6	volts
current	22	70	ma

Table 6. Microprocessor pin allocation				
pin	PIC24FJ256GB106	pin function	Chip resource	net name
1	PMD5/CN63/RE5	input	RE5	gas gauge alert
2	SCL3/PMD6/CN64/RE6	i2c	SCL3	gas gauge scl
3	SDA3/PMD7/CN65/RE7	i2c	SDA3	gas gauge sda
4	C1IND/ RP21/PMA5/CN8/RG6	output	RG6	RG6
5	C1INC/ RP26/PMA4/CN9/RG7	input	RG7	RG7
6	C2IND/ RP19/PMA3/CN10/RG8	uart tx	RP19	RG8
7	MCLR	icd	MCLR	
8	RP27/PMA2/C2INC/CN11/RG9	uart rx	RP27	RG9
9	VSS			
10	VDD			
11	PGEC3/AN5/C1INA/VBUSON/ RP18/CN7/RB5	uart cts	RP18	RB5
12	PGED3/AN4/C1INB/USBOEN/ RP28/CN6/RB4	input	RB4	external power sense
13	AN3/C2INA/VPIO/CN5/RB3	input	CN5/RB3	sw3
14	AN2/C2INB/VMIO/ RP13/CN4/RB2	user defined	user defined	RB2
15	PGEC1/AN1/VREF-/ RP1/CN3/RB1	icd	PGEC1	pgec1
16	PGED1/AN0/VREF+/ RP0/PMA6/CN2/RB0	icd	PGED1	pgec2
17	PGEC2/AN6/ RP6/CN24/RB6	input	CN24/RB6	sw2
18	PGED2/AN7/ RP7/RCV/CN25/RB7	analog	AN7	temperature
19	AVDD			
20	AVSS			
21	AN8/ RP8/CN26/RB8	SPI	RP8	memory sdo
22	AN9/ RP9/PMA7/CN27/RB9	SPI	RP9	memory sck
23	TMS/CVREF/AN10/PMA13/CN28/RB10	output	RB10	status
24	TDO/AN11/PMA12/CN29/RB11	input	CN/RB11	sw1
25	VSS			
26	VDD			
27	TCK/AN12/PMA11/CTED2/CN30/RB12	output	RB12	uid_ee_cs
28	TDI/AN13/PMA10/CTED1/CN31/RB13	output	RB13	sram_cs
29	AN14/CTPLS/ RP14/PMA1/CN32/RB14	SPI	RP14	memory sdi
30	AN15/ RP29/REFO/PMA0/CN12/RB15	SPI	RP29	radio_sdi
31	SDA2/ RP10/PMA9/CN17/RF4	output	RF4	RF4
32	SCL2/ RP17/PMA8/CN18/RF5	uart rts	RP17	RF5

Table 6.(continued) Microprocessor pin allocation				
pin	PIC24FJ256GB106	pin function	Chip resource	net name
33	RP16/USBID/CN71/RF3	USB	USBID	USBID
34	VBUS	USB		VBUS
35	VUSB	USB		VUSB
36	D-/RG3	USB	D-	D-
37	D+/RG2	USB	D+	D+
<b>38</b>	<b>VDD</b>			
39	OSCI/CLKI/CN23/RC12	OSCILATOR	OSCI	osci
40	OSCO/CLKO/CN22/RC15	OSCILATOR	OSCO	osco
<b>41</b>	<b>VSS</b>			
42	RTCC/DMLN/RP2/CN53/RD8	interrupt	RP2	mrf_irq_1
43	DPLN/SDA1/RP4/CN54/RD9	output	RD9	discharge
44	SCL1/RP3/PMCS2/CN55/RD10	SPI	RP3	radio_sck
45	RP12/PMCS1/CN56/RD11	SPI	RP12	radio_sdo
46	DMH/RP11/INT0/CN49/RD0	interrupt	INT0	mrf_int
47	SOSCI/C3IND/CN1/RC13	OSCILATOR	SOSCI	sosci
48	SOSCO/T1CK/C3INC/RI37/CN0/RC14	OSCILATOR	SOSCO	sosco
49	VCPCON/RP24/CN50/RD1	spi	RP24	display_sdi
50	DPH/RP23/CN51/RD2	output	RD2	display_reset
51	RP22/PMBE/CN52/RD3	output	RD3	mrf_reset
52	RP25/PMWR/CN13/RD4	spi	RP25	display_sdo
53	RP20/PMRD/CN14/RD5	spi	RP20	display_sck
54	C3INB/CN15/RD6	output	RD6	mrf_cs
55	C3INA/CN16/RD7	input	RD7	busy
<b>56</b>	<b>VCAP/VDDCORE</b>			
<b>57</b>	<b>ENVREG</b>			
58	VBUSST/VCMPST1/CN68/RF0	output	RF0	display_cs
59	VCMPST2/CN69/RF1	output	RF1	mrf_wake
60	PMD0/CN58/RE0	output	RE0	usb_power_control
61	PMD1/CN59/RE1	output	RE1	panel_on
62	PMD2/CN60/RE2	input	RE2	charge
63	PMD3/CN61/RE3	output	RE3	RE3
64	PMD4/CN62/RE4	output	RE4	RE4
<b>65</b>	<b>VSS</b>			

## **Firmware structure**

The firmware is written to utilize Microchips application libraries version v2015\_05\_15. The demo kit utilizes the graphics library, MiWi radio stack, USB stack and file I/O library. The firmware is structured with an initialize sleep function, initialization function followed with a forever loop, interrupt service routines and trap fault routines. The code is structured using non-blocking functions. This structure provides a cooperative multitasking environment through the use of state machines.

### **The switchXTAL () function :**

- Configures the clock to switch from the RC clock to the external crystal multiplied by 4 resulting in 32MHz

### **The SYSTEM\_InitializeBoard () function sets up the following:**

- Configures peripheral pins and remaps pins for SPI functionality, PWM 1, asynchronous TX and RX, and Interrupt inputs.
- Determines the cause of reset and trap errors
- Initialize change notice interrupt and enable weak pull-up on the 'select' key
- Enables the Watch Dog Timer
- Selects the main clock source to run at 32 MHz, sets up to operate real time clock calendar hardware function from external low power 32 kHz crystal, Power on Reset will set the clock to default values.
- SPI 1 functionality is assigned to radio communications, SPI 2 functions to communicate to the external memory devices, and SPI 3 communicates with the display
- Configures USB hardware
- Sets up watch dog timer to allow software control to enable or disable WDT in sleep. Timeout set to 17 seconds
- Configures weak pull-ups on three key pads and the battery charge status alert.
- Sets interrupt priority and nesting interrupts
- Configure I2C for communication with battery gas gauge IC.
- Set timer 4 16 bit mode with highest interrupt and time period of 10 milliseconds. Update "tick" every interrupt.
- Set timer 5 16 bit mode, time period of 1 millisecond. Used for display driver update
- Set timer 2 32 bit mode. Used for radio symbol timer
- If coordinator, sets pan id to 1234 and radio channel to 26. If end device, it will join a network with pan id 1234 on channel 26
- Configures UART TX,RX,CTS, and RTS

### **Act on reset condition**

- If the last detected reset is not a controlled software generated reset the device powers down and displays the last known reset and trap condition.
- If the last detected reset is from a software generated reset the program control continues to the forever polling loop.

### **The forever loop polls:**

- The user key pad, and interacts with the graphics stack, navigates the user menu with the left, right, select user keypads.
- Polls radio stack for remote devices joining the network.
- Clears watch dog timer
- Powers down for low power operation, wakes on watch dog time out, polls and returns to power down mode
- Toggles heart beat status led every second
- In the USB demo, checks for external thumb drive connection and performs periodic file writes
- In the RSSI demo, the coordinator initiates a receive signal strength test with a remote device. The remote devices echo the message from the coordinator. The coordinator determines the received signal strength and displays the data on a strip chart.

- *In the battery demo, the battery charge status is updated when the coulomb count changes.*
- *In the Bluetooth loop back demo, echo back the parsed message*

### *The power down sequence:*

- *Updates the display with reset and trap condition*
- *Commands radio module to low power state*
- *Commands gas gage to low power state*
- *Performs software reset*
- *Sets I/O for low power mode*
- *Turns off the wdt*
- *Issues Sleep() command*

### *The wake up sequence:*

- *Interrupt is generated from the select key and wakes the processor*
- *Issue a reset command*

### *Interrupt handling*

- *Interrupts int0 and int1 are utilized by the wireless module*
- *Change notice interrupt are assigned to the three key pads and are used to wake the processor from sleep*
- *Timer 4 interrupt is for updating "tick"*
- *USB host interrupt for updating the USB state machine on the insertion or removal of the USB memory device*
- *Watch Dog Timer interrupt to wake from low power operation*

### *Trap Fault*

- *On the occurrence of a trap fault the status led will blink rapidly until the watch dog timer expires. Watch dog time out is set for about 17 seconds and will allow to observe the fault condition. Watch dog will reset the device and on the next wake up the fault will be displayed on the screen. Power on reset will not retain the trap fault and does not maintain the real time clock settings.*

## **Initialize Hardware**

*The system begins with the connection of external power. Figure 7. Shows the power down screen with the Reset and Trap condition, ID, firmware and hardware version are displayed. The system initializes the pin assignments, determines the type of reset and fault condition then enters sleep mode. In sleep mode the real time clock is operating and the change notice interrupts are enabled. Pressing the 'select', S3 button wakes the processor from sleep and begins to further initialize the hardware. Starting with Figure 8 the display updates with the current initialization step. The following screen captures show a typical initialization cycle. The screen is updated every 2 seconds*





Figure 7 Power Down , Reset, Trap, Revision and Device ID

Figure 8 displays the firmware and hardware revision in the format: REV firmwareRev.hardwareRev currently showing firmware version 00 and hardware version 4.



Figure 8. Revision



Figure 9. Reset, Trap and Battery status

The next screen, Figure 9, shows the recent reset and Trap condition. Trap errors occur from Oscillator Fail, Address Error, Stack Error, Math Error, or Default Interrupt. When a trap occurs the status led flashes faster and the watchdog timer will expire and reset the processor. The trap error is stored in a persistent variable and will be displayed on the next time the processor wakes from sleep. There are 9 reset conditions: Power-on, MCLR, RESET Instruction, Watchdog Timer, Brown-out, Configuration Mismatch, Trap Conflict Illegal Opcode Instruction and Uninitialized W Register. The screen also includes if the device is a Pan Coordinator or an End device and battery condition. In sequence, Figure 10 shows this device will be a Pan Coordinator with a good battery.

Two seconds later, figure 11, updates the screen with the radio channel. After reset, the processor runs on the internal 8 MHz RC clock. On initialization the clock frequency will switch over to either external 8 MHz clock running at 32MHz or if unsuccessful run on the internal clock running at 32MHz. USB timing tolerance requires the external clock source. Once the clock source is determined, Figure 12, shows the unique identification number and the network PAN ID. After establishing the system clock the initialization continues and configures the radio hardware and software stack. If the device is a PAN Coordinator the network will be created; otherwise the device will search to join a network. Figure 13 shows successful network creation and displays either 'Pan Coordinator' or 'End Device'. Figure 14 finishes the initialization process showing the Main menu screen



Figure 10. Battery Status



Figure 11. Radio Channel



Figure 12. Pan ID



Figure 13. Pan Coordinator



Figure 14. Main Screen

## Demo Navigation

There are four demonstrations showing hardware and firmware interaction:

- Battery Demo
- Radio Signal Strength Indication
- USB file creation and data capture
- Bluetooth loopback

## Battery Demo

The Battery demo polls data from LTC2941 using I2C bus. The demo also determines the battery charger status by determining the duty cycle output from LTC4065. The Battery demo shows:

- If the device is externally powered; determined from a discrete i/o
- Charge complete, Charging, temperature fault, battery failure; LTC4065, determined from the pwm duty cycle
- Coulombs in and out of the battery; LTC2941, determined from requesting register values over I2C
- Real time clock to time stamp, can be used to plot coulombs vs. time

Applying external power wakes a sleeping processor to indicate that the device is on external power and charging the battery. The detection of external power is through a voltage divider triggering a change notice input pin. Charger status occurs by monitoring the pwm duty cycle output of the LTC4065 CHRГ pin. When the battery is charging the CHRГ pin is low and when the charge current drops to 10% of full-charge current, the CHRГ pin is forced to a high impedance state. If the battery voltage remains below 2.9 volts for one quarter of the charge time, the battery is considered defective and the CHRГ pin pulses at a frequency of 2Hz with a 75% duty cycle.

Battery charge status is done by measuring the charge flow in and out of the battery and the microprocessor reads the charge register over the I2C connection. On initial battery insertion the coulomb count is set to half scale 32,000. This number decreases or increases depending on the direction of current flow. On initial battery insertion the battery charge status is unknown. The battery must complete a charge cycle in order to set the coulomb value. The microprocessor monitors the CHRГ pin and sets the coulomb count when the CHRГ pin goes high. The coulomb value helps the developer determine the high, low and scale factors for representing accurate battery level.

Navigating to the Battery demo is done by moving the cursor to the utilities selection and press the select key. This will bring you to the UTILITIES menu. With "BatMon" highlighted, press the select key to enter into the BATTERY demo. Press 'OK' to end the demo and return to the main display. Figure 18 shows no external power connection and a decreasing coulomb value with the next timestamp.



Figure 15. Select "Utilities"



Figure 16. Select "Bat Mon"



Figure 17. Initializing Battery test



Figure 18. Coulomb count and timestamp



Figure 19. Coulomb count and 45 minute timestamp delta

## Radio Signal Strength Indication Demonstration

The Radio Signal Strength Indication (RSSI) demo requires two devices. The RSSI demo requires a PAN Coordinator and an End device. In this demo, the PAN Coordinator sends a unicast message to the first device in the device list. This message requests the End device to respond with its RSSI value. The end device responds with a message packet with its RSSI, battery condition and temperature. Next, the Pan Coordinator plots the RSSI data on a strip chart. This demo is helpful to determine radio strength budget and signal robustness. The '-' key will plot data at a slower rate while the '+' key will increase the plot rate. The demo uses both partial and full update. After every 10 partial updates the screen is updated with a full display update. After the first full update the screen hides the soft keys.



Figure 20. Select "RSSI"



Figure 21. Test Start with soft keys displayed

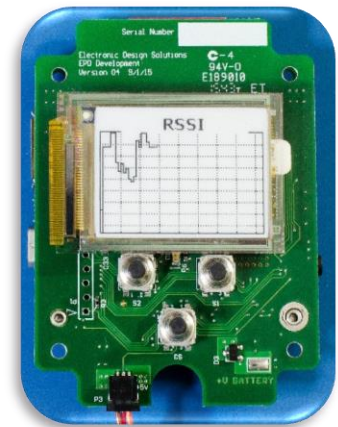

Figure 22. Moving remote device and plotting signal strength

## USB demo

With the PIC24FJ256GB110 family of devices, Microchip introduces USB On-The-Go functionality on a single chip to its product line. This new module provides on-chip functionality as a target device compatible with the USB 2.0 standard, as well as limited stand-alone functionality as a USB embedded host. By implementing USB Host Negotiation Protocol (HNP), the module can also dynamically switch between device and host operation, allowing for a much wider range of versatile USB-enabled applications on a microcontroller platform. In addition to USB host functionality, PIC24FJ256GB110 family devices provide a true single-chip USB solution, including an on-chip transceiver and voltage regulator, and a voltage boost generator for sourcing bus power during host operations.

After navigating from the Main menu press the left button once to highlight the 'USB Test', Figure 23 shows the selection highlighted. Next press the select button to begin the demo. At this stage the demo is prompting the user to insert a thumb drive as shown in Figure 24. The insertion of the drive causes an interrupt and the USB state machine advances to the next state. After detecting the flash drive the demo begins by creating a file named 'EDS\_month\_day.xls'. Comma separated data is periodically written every 100 ms until 1000 data points are captured. Pressing 'OK' will end the demo and return to the main menu. Removing the memory device before ending the demo will lose the last buffer data. Figure 25 removes the prompt and is now collecting data.



Figure 23. Select "USB Test"



Figure 24. User prompt for USB drive

Figure 26 prompts for the removal of the USB flash drive and an interrupt is generated on its removal. This interrupt will advance the USB state machine. Figure 27 validates the data capture.



Figure 25. Collecting 1000 data points



Figure 26. Capture complete, prompting user to remove drive

	A	B	C	D	E
5077	1001	1003			
5078	TEST#		1 type:	1	
5079	Mon 10:22:02	20-Mar	2015		
5080	1	3			
5081	2	4			
5082	3	5			
5083	4	6			
5084	5	7			
6069	990	992			
6070	991	993			
6071	992	994			
6072	993	995			
6073	994	996			
6074	995	997			
6075	996	998			
6076	997	999			
6077	998	1000			
6078	999	1001			
6079	1000	1002			
6080	1001	1003			

Figure 27. Appended data to file MAR20EDS file. Data points 6 through 989 hidden

## Bluetooth Low Energy Demo

The Bluetooth loop back demo implements Microchips low power data profile with a connection to a smart Android device. Navigate to the BLE menu to initiate the loop back demo as seen in Figure 28. There are three Led status indicators: wake, event and connection. The wake status led indicates that the radio is awake and active, Figure 30. The connect led indicates that the radio is connected and the Event led is only triggered in Command mode and illuminates when MLDP data is received, Figure 31. The demo starts by initializing the radio and then issues a reset command to commit the new parameters. The wake led will blink once during the reset. At this point the radio advertises and waits to connect to the android smart device. Start the android MLDP application and monitor the scan screen. Figure 32 shows the device on the scan list. Next, select the device and then observe the connection led illuminate, Figure 31. On the outgoing screen type in a test string and hit enter. The demo parses the received ascii string for a '\r' (return character) and is sent back to the android device. Figure 34 shows a successful loop back demo.



Figure 28. Select "BLE" to start the demo



Figure 29. Prompting user to connect





Figure 30. Wake led on



Figure 31. Both Wake and Connected led illuminated



Figure 32. BLE in the device list



Figure 33. Device in connected state



Figure 34. "Hello World" message echoed and displayed





Figure 36 GPS3 click



Figure 37. Heart rate click



Figure 38. IrThermo click



Figure 39. RFID click



Figure 40. Thunder Click

## Project Configuration

This section gives a brief overview of the project configuration. The project gives examples to easily compile code to use different radio modules, select either Pan Coordinator or full function end device mode, USB function, type of display, and the type of option board. Keep in mind that care is required when selecting the project that matches the hardware. Example, inappropriate display selection will keep the display from working.

**Configurations:**

Radio	Mode	Display	Option Board
24J40	COORD_HOST	g2mb	BLE (active)
24J40	COORD_HOST	g2ma	BLE
24J40	END	g2ma	BLE
24J40	END	g2mb	BLE
89xa	COORD_HOST	g2mb	rfid
89xa	COORD_HOST	g2mb	HR
89xa	COORD_HOST	g2mb	thunder
89xa	COORD_HOST	g2mb	IR
89xa	COORD_HOST	g2mb	BLE
89xa	COORD_HOST	g2ma	BLE
89xa	END_HOST	g2ma	BLE
89xa	END_HOST	g2mb	BLE

**RADIO**  
 89XA: 900 MHz  
 24J40: 2.4 GHz

**MODE**  
 COORD: PAN COORDINATOR  
 END: FULL FEATURE END DEVICE

**USB HOST DEVICE**

**DISPLAY**  
 g2mb: 0-50C supports partial update  
 g2ma: -20-50C

**OPTION BOARD**  
 rfid: STMicro CR95HF  
 hr: Maxim MAX30100  
 thunder: AustriaMicroSystems as3935  
 ir: Melexis MLX90614  
 BLE: Microchip RN4020

Figure 41. Project Configuration

## Components

This section gives a brief overview of the components in the kit and the microprocessor pin allocation.

The LTC2941 measures battery charge state in battery supplied handheld PC and portable product applications. Its operating range is perfectly suited for single-cell Li-Ion batteries. A precision coulomb counter integrates current through a sense resistor between the battery's positive terminal and the load or charger. The measured charge is stored in internal registers. An I2C interface accesses and configures the device. The LTC2941 features programmable high and low thresholds for accumulated charge. If a threshold is exceeded, the device communicates an alert using either the I2C alert protocol or by setting a flag in the internal status register. The LTC2941 requires only a single low value external sense resistor to set the current range.

The LTC4065 is a complete constant-current/constant-voltage linear charger for single-cell lithium-ion batteries. The 2mm x 2mm DFN package and low external component count make the LTC4065 especially well-suited for portable applications. Furthermore, LTC4065 is specifically designed to work within USB power specifications. The CHR<sub>G</sub> pin indicates when charge current has dropped to ten percent of its programmed value (C/10). An internal timer terminates charging according to battery manufacturer specifications. No external sense resistor or blocking diode is required due to the internal MOSFET architecture. Thermal feedback regulates charge current to limit the die temperature during high power operation or high ambient temperature conditions. When the input supply (wall adapter or USB supply) is removed, the LTC4065 automatically enters a low current state, dropping battery drain current to less than 4µA. The LTC4065 also includes automatic recharge, low-battery charge conditioning (trickle charging), soft-start (to limit inrush current). This charge resistor is set to charge a 100 mA-h battery at a 1c rate.

The LTC<sup>®</sup>3531/LTC3531-3.3/LTC3531-3 are synchronous buck-boost DC/DC converters that operate from input voltages above, below or equal to the output voltage. The topology incorporated in the ICs provides a continuous transfer through all operating modes, making the product ideal for single cell Li-Ion and multicell alkaline or nickel applications. The converters operate in Burst Mode, minimizing solution footprint and component count as well as providing high conversion efficiency over a wide range of load currents.

The MCP1640/B/C/D is a compact, high-efficiency, fixed frequency, synchronous step-up DC-DC converter. It provides an easy-to-use power supply solution for applications powered by either one-cell, two-cell, or three-cell alkaline, NiCad, NiMH, one-cell Li-Ion or Li-Polymer batteries. Low-voltage technology allows the regulator to start up without high inrush current or output voltage overshoot from a low 0.65V input. High efficiency is accomplished by integrating the low resistance N-Channel Boost switch and synchronous P-Channel switch. All compensation and protection circuitry are integrated to minimize external components. For standby applications, the MCP1640 operates and consumes only 19 µA while operating at no load, and provides a true disconnect from input to output while shut down (EN = GND). Additional device options are available that operate in PWM-only mode and connect input to output bypass while shut down

Table 6 shows the microcontroller pin allocation for the LTC2941, LTC4065 and the MCP1640.

Table 7. Power pin allocation				
pin	PIC24FJ256GB106	pin function	Chip resource	net name
2	SCL3/PMD6/CN64/RE6	i2c	SCL3	gas gauge scl
3	SDA3/PMD7/CN65/RE7	i2c	SDA3	gas gauge sda
1	PMD5/CN63/RE5	input	RE5	gas gauge alert
12	PGED3/AN4/C1INB/USBOEN/ <b>RP28</b> /CN6/RB4	input	RB4	external power sense
62	PMD2/CN60/RE2	input	RE2	charg
60	PMD0/CN58/RE0	output	RE0	usb_power_control

The Microchip Technology Inc. 25AA02UID is a 2 Kbit Serial Electrically Erasable Programmable Read-Only Memory (EEPROM) with a preprogrammed, 32-bit unique ID. The memory is accessed via a simple Serial Peripheral Interface (SPI) compatible serial bus. The bus signals required are a clock input (SCK) plus separate data in (SI) and data out (SO) lines. Access to the device is controlled through a Chip Select (CS) input.

The Microchip Technology Inc. 23X256 are 256 Kbit Serial SRAM devices. The memory is accessed via a simple Serial Peripheral Interface (SPI) compatible serial bus. The bus signals required are a clock input (SCK) plus separate data in (SI) and data out (SO) lines. Access to the device is controlled through a Chip Select (CS) input.

Table 8 shows the microcontroller pin allocation for the 25AA02UID and 23X256. Both memory devices share the spi bus.

Table 8. Memory pin allocation				
pin	PIC24FJ256GB106	pin function	Chip resource	net name
28	TDI/AN13/PMA10/CTED1/CN31/RB13	output	RB13	sram_cs
27	TCK/AN12/PMA11/CTED2/CN30/RB12	output	RB12	uid_ee_cs
21	AN8/ RP8 /CN26/RB8	SPI	RP8	memory_sdo
22	AN9/ RP9 /PMA7/CN27/RB9	SPI	RP9	memory_sck
29	AN14/CTPLS/ RP14 /PMA1/CN32/RB14	SPI	RP14	memory_sdi

The MRF89XAM9A is an ultra-low-power sub-GHz surface mount transceiver module with integrated crystal, internal voltage regulator, matching circuitry and PCB antenna. The MRF89XAM9A module operates in the United States/Canada 902–928 MHz ISM frequency band. The integrated module design frees the integrator from extensive RF and antenna design, and regulatory compliance testing, by allowing quicker time to market. The MRF89XAM9A module is compatible with Microchip's MiWi™ Development Environment software stacks. The software stacks are available as a free download, including source code, from the Microchip's web site <http://www.microchip.com/wireless>. The MRF89XAM9A module has received regulatory approvals for modular devices in the United States (FCC) and Canada (IC). Modular device approval removes the need for expensive RF and antenna design, and allows the user to place the MRF89XAM9A module inside a finished product and it does not require regulatory testing for an intentional radiator (RF transmitter).

Table 9 shows the microcontroller pin allocation for the MRF89XAM9A.

Table 9. Radio pin allocation				
pin	PIC24FJ256GB106	pin function	Chip resource	net name
46	DMH/ RP11 /INT0/CN49/RD0	interrupt	INT0	mrf_int
42	RTCC/DMLN/ RP2 /CN53/RD8	Interrupt	RP2	mrf_irq_1
51	RP22 /PMBE/CN52/RD3	output	RD3	mrf_reset
54	C3INB/CN15/RD6	output	RD6	mrf_cs
59	VCMPST2/CN69/RF1	output	RF1	mrf_wake
30	AN15/ RP29 /REFO/PMA0/CN12/RB15	SPI	RP29	radio_sdi
44	SCL1/ RP3 /PMCS2/CN55/RD10	SPI	RP3	radio_sck
45	RP12 /PMCS1/CN56/RD11	SPI	RP12	radio_sdo

The Microchip Technology Inc. PIC24FJ256GB106 has a rich feature set. Please refer to PIC24FJ256GB110 FAMILY documentation for complete details. This development board feature set includes:

- Switch between Clock Sources in Real Time
- USB host and device
- Up to 16 MIPS Operation at 32 MHz
- 8 MHz Internal Oscillator
- 10-Bit, Up to 16-Channel Analog-to-Digital (A/D) Converter at 500 Ksps:
- Three 3-Wire/4-Wire SPI
- I2C™ modules support Multi-Master/Slave modes
- UART modules: Supports RS-485, RS-232, LIN/J2602 protocols and IrDA®
- Five 16-Bit Timers/Counters
- Compare/PWM Outputs, each with a Dedicated Time Base
- Hardware Real-Time Clock/Calendar (RTCC): Provides clock, calendar and alarm functions
- Up to 5 External Interrupt Sources

The RN4020 is a fully-certified, Bluetooth Version 4.1 low energy module for designers who want to easily add low power wireless capability to their products. The small form factor, surface mount module has the complete Bluetooth stack on-board and is controlled via simple ASCII commands over the UART interface. The RN4020 also includes all Bluetooth SIG profiles, as well as MLDP (Microchip Low-energy Data Profile) for custom data. Developers can utilize the scripting feature to enable standalone operation without a host MCU or Processor. The RN4020 can be remote controlled by another module over a secure connection and can be updated via the UART interface or over-the-air.

The RN4020 has a built-in high performance PCB antenna optimally tuned for long range, typically over 100 meters. The compact size, 11.5 x 19.5 x 2.5mm, enables ease of integration in size-constrained applications. The RN4020 can be used with any low cost microcontroller for intelligent Bluetooth Low Energy applications. The RN4020 is fully-certified, has the complete Bluetooth stack on-board the module, and is controlled via a simple ASCII UART interface, making it a true drop-in solution that is easy to use, and easy to prototype, greatly speeding time to market.

Table 10. Bluetooth and USB pin allocation through the external connector P2

pin	PIC24FJ256GB106	pin function	Chip resource	net name
5	C1INC/ RP26 /PMA4/CN9/RG7	input	RG7	RG7
4	C1IND/ RP21 /PMA5/CN8/RG6	output	RG6	RG6
31	SDA2/ RP10 /PMA9/CN17/RF4	output	RF4	RF4
63	PMD3/CN61/RE3	output	RE3	RE3
64	PMD4/CN62/RE4	output	RE4	RE4
11	PGEC3/AN5/C1INA/VBUSON/ RP18 /CN7/RB5	uart cts	RP18	RB5
32	SCL2/ RP17 /PMA8/CN18/RF5	uart rts	RP17	RF5
8	RP27 /PMA2/C2INC/CN11/RG9	uart rx	RP27	RG9
6	C2IND/ RP19 /PMA3/CN10/RG8	uart tx	RP19	RG8
33	RP16 /USBID/CN71/RF3	USB	USBID	USBID
36	D-/RG3	USB	D-	D-
37	D+/RG2	USB	D+	D+
14	AN2/C2INB/VMIO/ RP13 /CN4/RB2	user defined	user defined	RB2

The MCP9700/9700A and MCP9701/9701A family of Linear Active Thermistor™ Integrated Circuit (IC) is an analog temperature sensor that converts temperature to analog voltage. It's a low-cost, low-power sensor with an accuracy of ±2°C from 0°C to +70°C (MCP9700A/9701A) ±4°C from 0°C to +70°C (MCP9700/9701) while consuming 6 uA (typical) of operating current.

1.44" E-Paper Panel made by Pervasive Displays. This E-Paper panel is the most power efficient, easy to read, industrial purposed reflective E-Paper display on the market. By combing the high resolution of a TFT backplane and the dependability/maturity of E Ink technology, this display offers its user the freedom to display any image with excellent definition and contrast. The small and thin form factor makes it easy to design it into a variety of applications. This is a 1.44" a-Si, active matrix TFT, Electronic Paper Display (EPD) panel. The panel has such high resolution (111 dpi) that it is able to easily display fine patterns. Due to its bi-stable nature, the EPD panel requires very little power to update and needs no power to maintain an image.

Features:

- Resolution: 128 x 96
- Ultra-low power consumption
- Super Wide Viewing Angle - near 180°
- Extra thin & light
- SPI interface

Table 11 shows the microcontroller pin allocation for the e-paper display and analog temperature sensor.

Table 11. display pin allocation				
pin	PIC24FJ256GB106	pin function	Chip resource	net name
18	PGED2/AN7/RP7/RCV/CN25/RB7	analog	AN7	temperature
55	C3INA/CN16/RD7	input	RD7	busy
43	DPLN/SDA1/RP4/CN54/RD9	output	RD9	discharge
50	DPH/RP23/CN51/RD2	output	RD2	display_reset
58	VBUSST/VCMPST1/CN68/RF0	output	RF0	display_cs
61	PMD1/CN59/RE1	output	RE1	panel_on
49	VCPCON/RP24/CN50/RD1	spi	RP24	display_sdi
52	RP25/PMWR/CN13/RD4	spi	RP25	display_sdo
53	RP20/PMRD/CN14/RD5	spi	RP20	display_sck

The system level diagram is depicted in Figure 35. The diagram highlights the system integration, microcontroller resources and power interconnect. The top part of the diagram shows the wireless E-Paper board and the lower part shows the optional Bluetooth/USB breakout board. The connection interface is through a 2x10 .050" micro header from Samtec. The following three figures show the detailed wiring schematic. The main schematic E-paper development kit schematic, Figure 36, has two sub schematics Display shown in Figure 37, and Power shown in Figure 38.



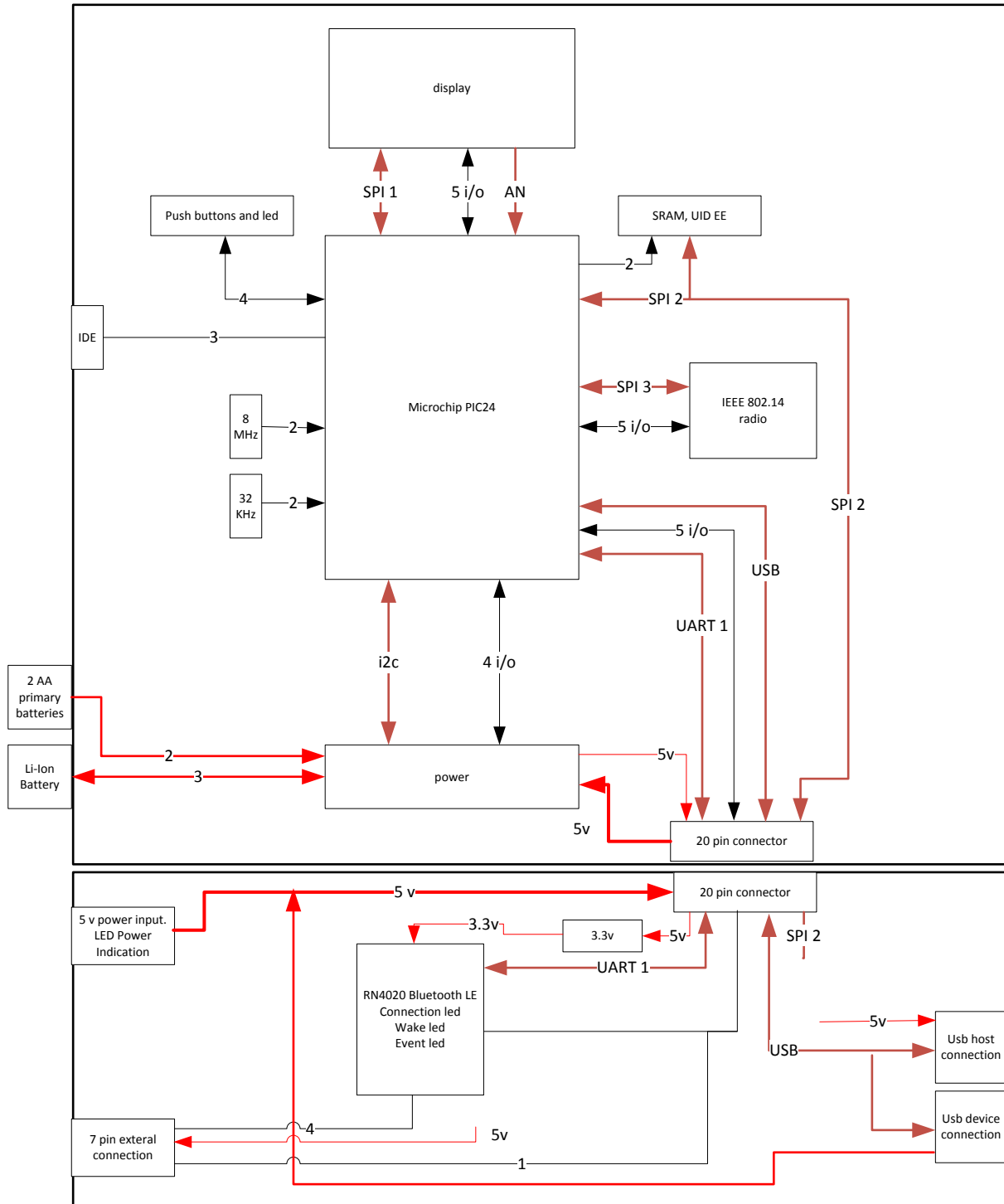

Figure 42. System block diagram







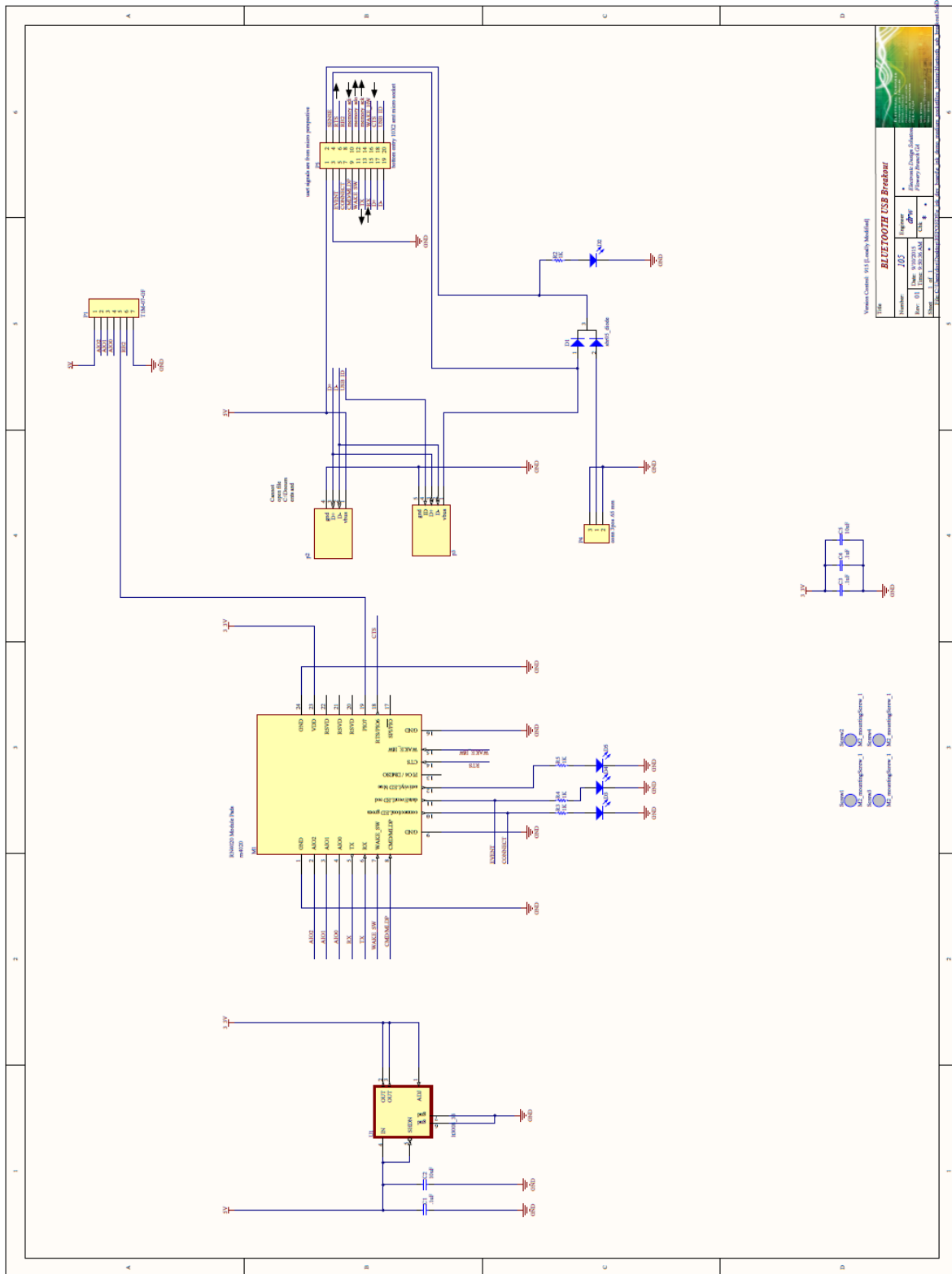

Figure 46. Top level Bluetooth/USB

The following figures are top and bottom Gerber screen captures of the E-Paper development and Bluetooth/USB breakout boards. These figures show a composite of copper traces, component silkscreen and solder paste locations.

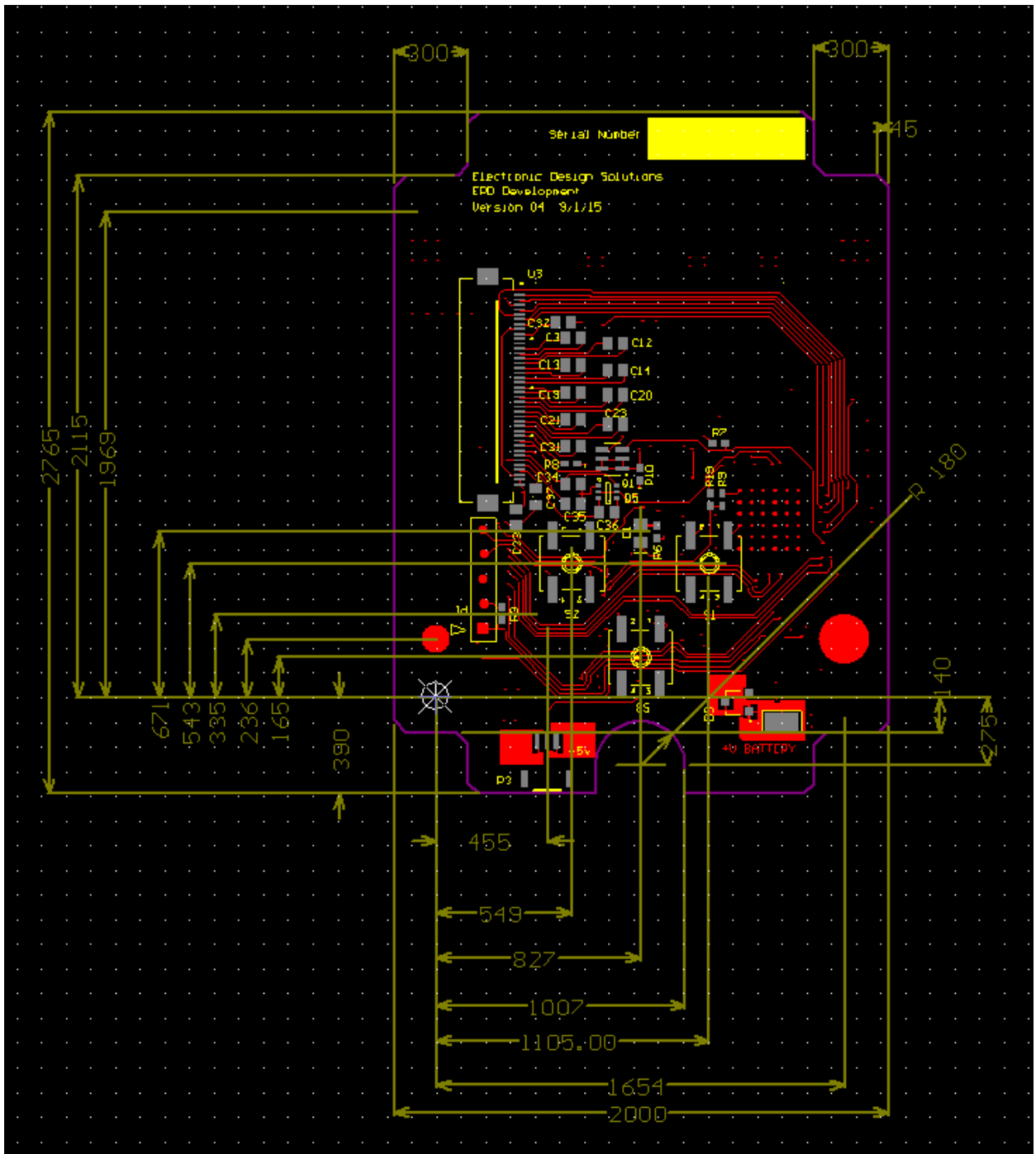

Figure 47. Top layer PCB

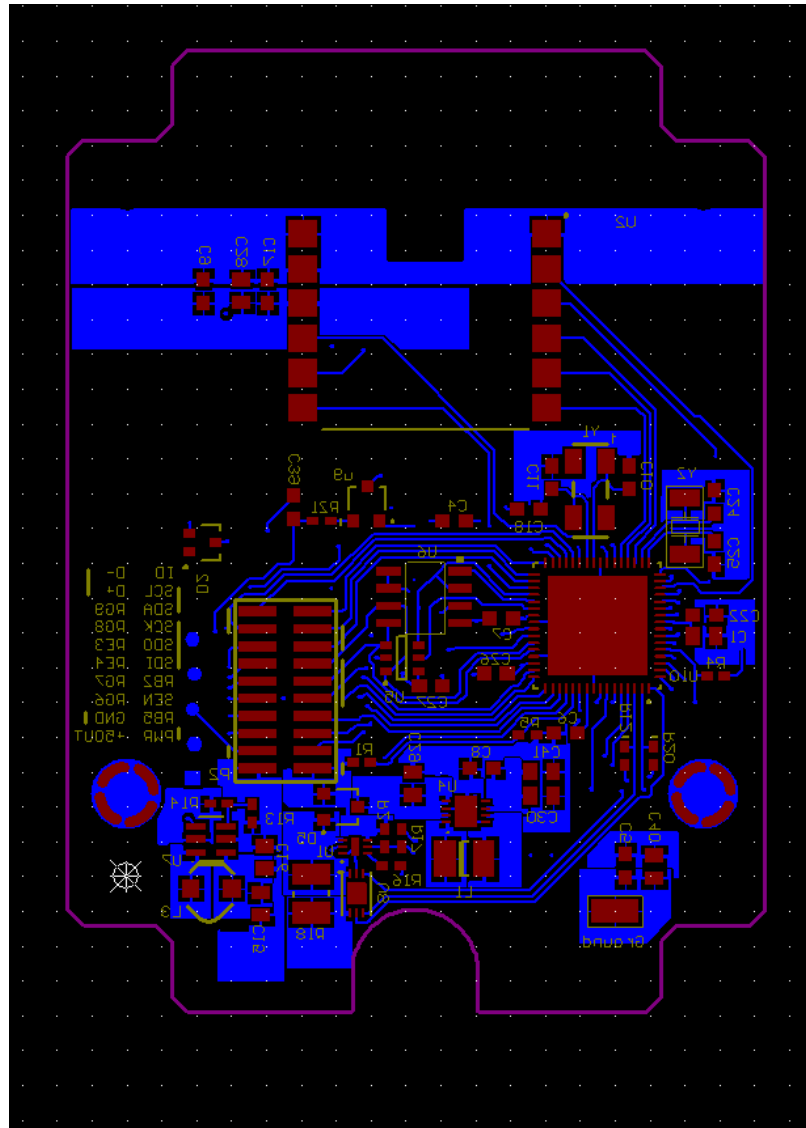

Figure 48. Bottom Layer PCB

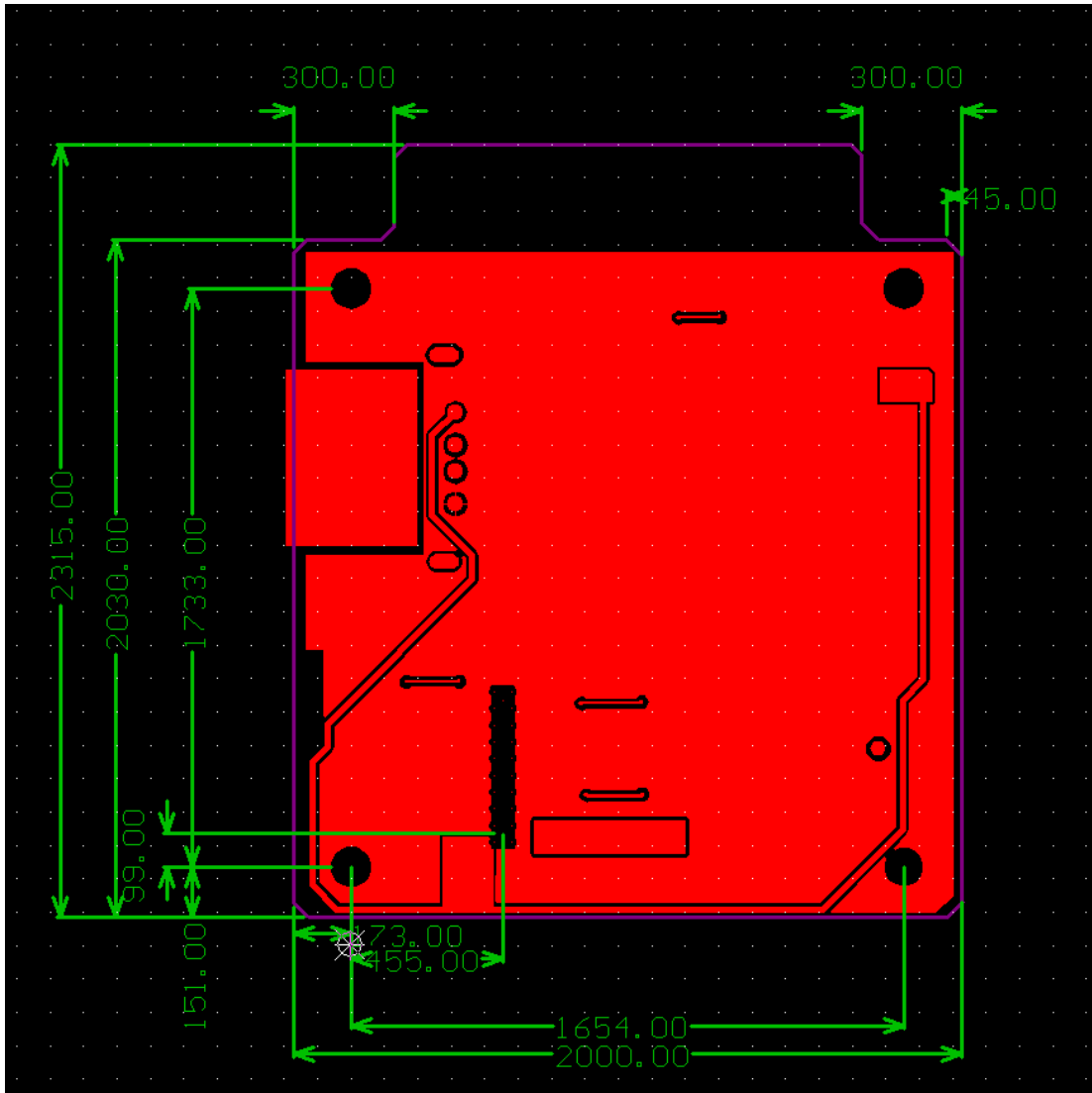

Figure 49. Bluetooth top layer



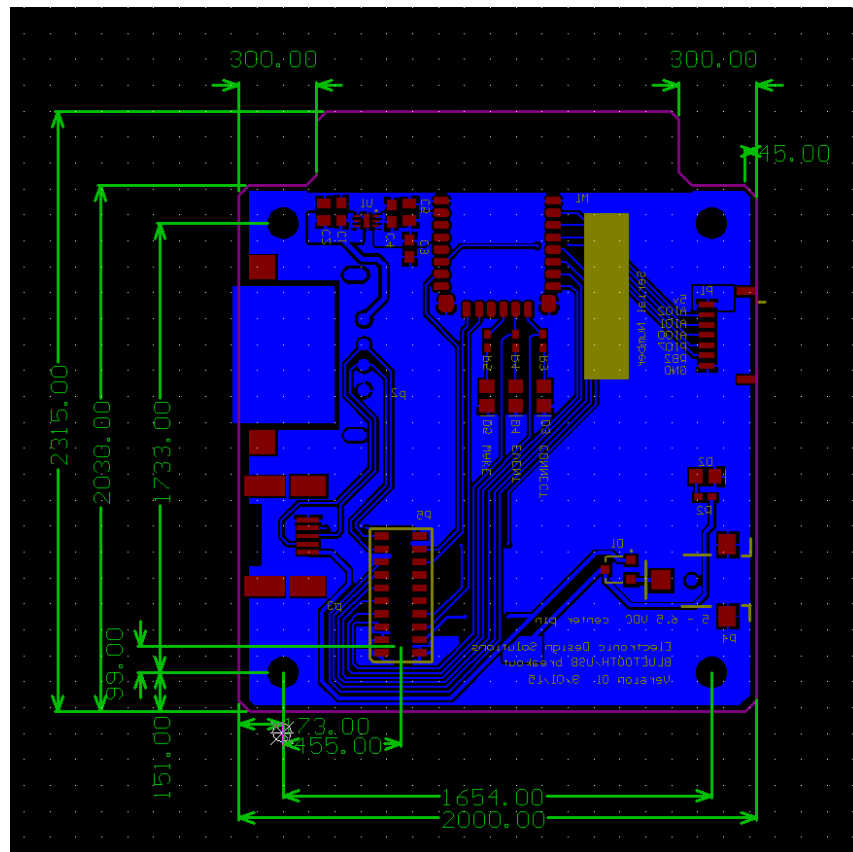
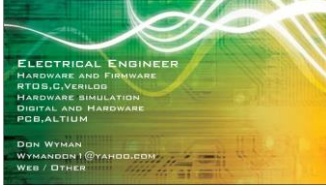

Figure 50. Bluetooth/USB breakout Bottom layer

 <b>Component list</b>			E-paper development kit	
<b>Source Data From:</b> <b>Project:</b> <b>Variant:</b>			<b>e_ink_pocket_box_medium.PrjPcb</b> <b>e_ink_pocket_box_medium.PrjPcb</b> <b>production</b>	
<b>Report Date:</b> <b>Print Date:</b>			<b>9/2/2015</b> <b>10-Sep-15</b>	
Description	Quantity	Designator	digikey	Total Price (\$)
CAP CER 10UF 10V X7R 0805	6	C1, C16, C28, C29, C30, C41	490-3905-2-ND	
CAP CER 2.2UF 25V 10% X7R 0805	14	C3, C12, C13, C14, C19, C20, C21, C23, C31, C32, C34, C35, C36, C37	1276-2953-2-ND	
CAP .1UF 25V CERAMIC X7R 0603, Capacitor	11	C4, C6, C7, C8, C9, C17, C18, C22, C26, C27, C39	PCC2277TR-ND	
CAP CER 47PF 50V 5% NP0 0603	1	C10	709-1145-2-ND	
CAP CER 20PF 50V 5% COG 0603	2	C11, C25	490-1410-2-ND	
CAP CER 4.7UF 25V Y5V 0805	1	C15	445-3461-2-ND	
CAP CER 10PF 50V X7R 0603	1	C24	06035C100KAT2A-ND	
CAPACITOR-0805, 1uF 10V CERAMIC X5R RoHS	1	C33	PCC1807TR-ND	
LED 660NM RED WTR CLR 0805 SMD	1	D1	511-1286-2-ND	
DIODE SCHOTTKY 30V 200MA SOT323	1	D2	BA T54SWT-TPTR-ND	
DIODE SBR 20V 500MA SC59	2	D3, D5	SBR05U20SNDICT-ND	
INDUCTOR 10UH 450MA 1210	1	L1	490-4059-2-ND	
INDUCTOR POWER 4.7UH 1A SMD	1	L3	308-1645-2-ND	
Header, 10-Pin, Dual row ,1.27mm	1	P2	FTSH-110-05-L-DV-A-P-TR	
connector smt 3 position 1MM	1	P3	T1M-03-T-S-RA-TR	
MOSFET P-CH 20V 2.3A SOT23-6	1	Q1	ZXM62P02E6TR-ND	
MOSFET 2N-CH 60V 180MA SOT363	1	Q5	2N7002DWA-7DTR-ND	
RES 100K OHM 1/16W 1% 0402 SMD	6	R1, R2, R4, R5, R9, R14	RH1M100KCDTR-ND	
RES 10.0K OHM 1/16W 1% 0402 SMD	2	R3, R7	541-10.0KLTR-ND	
RES 1.00K OHM 1/16W 1% 0402 SMD	1	R6	541-1.00KLTR-ND	
RES 2K OHM 1/16W 1% 0402 SMD	5	R8, R10, R12, R20, R21	RMCF0402FT2K00TR-ND	
RES 316K OHM 1/16W 1% 0402 SMD	1	R13	541-316KLTR-ND	
RES SMD 4.75K OHM 1% 1/16W 0402	1	R16	311-4.75KLTR-ND	
THERMISTOR NTC 100K OHM 5% 0402	1	R17	541-1094-2-ND	
RES .12 OHM 1/2W 1% 1210 SMD	1	R18	RH1M.12STR-ND	
RES 100 OHM 1/16W 1% 0402 SMD	1	R19	541-100LTR-ND	
SWITCH TACTILE SPST-NO 0.01A 32V	3	S1, S2, S3	401-1788-2-ND	
ROUND STANDOFF M2 STEEL 3MM	2	Screw5, Screw6	732-7085-6-ND	
IC CHARGER LH-ION 6-DFN	1	U1	LTC4069EDC#TRMPBF-ND	
IC SENSOR THERMAL 2.3V SOT23-3	1	u9	MCP9700T-E#TTTR-ND	
IC TXRX MOD 915MHZ ULP SUB-GHZ	1	U2	MRF89XAM9A-I#RM-ND	
CONN FPC/FFC 40POS .5MM HORZ SMD	1	U3	HFK140TR-ND	
IC REG BUCK BOOST SYNC 3.3V 8DFN	1	U4	LTC3531EDD-3.3#TRPBF-ND	
IC EEPROM 2KBIT 10MHZ SOT23-6	1	U5	25AA02UIDT-I#OTCT-ND	
IC SRAM 256KBIT 20MHZ 8SOIC	1	U6	23K256-I#SN-ND	
IC REG BST SYNC ADJ 0.1A SOT23-6 Disconnect	1	U7	MCP1640BT-V#HYTR-ND	
IC FUEL/GAS GAUGE LH-ION 6DFN	1	U8	LTC2941IDCB#TRMPBFTR-ND	
IC MCU 16BIT 256KB FLASH 64QFN	1	U10	PIC24FJ256GB106-I#MR-ND	
CRYSTAL 8.000 MHZ 18PF SMD	1	Y1	535-9720-2-ND	
CRYSTAL 32.768 KHZ SMD 12.5PF	1	Y2	535-9806-2-ND	
			<b>TOTAL PRICE</b>	

Component list			BLUETOOTH USB Breakout	
			Source Data From:	
			Project:	
			Variant:	
			bluetooth_usb_breakout.PrjPcb	
			bluetooth_usb_breakout.PrjPcb	
			Variant of bluetooth_usb_breakout_production	
Report Date:			9/2/2015	
Print Date:			10-Sep-15	
Description	Quantity	Designator	digkey	Total Price (\$)
CAP .1UF 25V CERAMIC X7R 0603, Capacitor	3	C1, C3, C4	PCC2277TR-ND	
CAP CER 10UF 10V X7R 0805	2	C2, C5	490-3905-2-ND	
DIODE SBR 20V 500MA SC59	1	D1	SBR05U20SNDICT-ND	
LED 660NM RED WTR CLR 0805 SMD	4	D2, D3, D4, D5	511-1286-2-ND	
MODULE BLUETOOTH 4.1 W/ANT	1	M1	RN4020-V/RM-ND	
connector smt 7 position 1MM	1	P1	T1M-07-T-S-RA-TR	
CONN PWR JACK 0.65X2.6MM SMT	1	P4	CP-040RJTR-ND	
socket, 10-Pin, Dual row, 1.27mm	1	P5	QLP-110-02-F-D-BE-A-K-TR	
CONN RCPT USB 4POS RT ANG T/H	1	p2	WM7087CT-ND	
CONN RECEPT USB 5POS RT ANG SMD	1	p3	WM17122TR-ND	
RES 1.00K OHM 1/16W 1% 0402 SMD	4	R2, R3, R4, R5	541-1.00KLTR-ND	
IC REG LDO 3.3V 20MA 6DFN	1	U1	LT3008EDC-3.3#TRMPBFTR-ND	
			<b>TOTAL PRICE</b>	

## Enclosure

The enclosure is an off the shelf water resistant IP54 from OKW. The Datec-Pocket-Box is a Compact Handheld Enclosure.

The attractive pocket-sized DATEC-POCKET-BOX enclosures offer a remarkable amount of technology in a minimum of space, as well as sturdy construction. Some of the features include:

- thin profile for comfortable holding
- plain surfaces allow easier machining for the interfaces
- battery compartment can accommodate 2 AAA batteries
- standard versions with pre-fitted sealing gaskets provide greater protection against dust and water entry
- Recessed operating area for protecting the membrane keypad or decorative foil/label
- White and black colors
- ABS (UL 94 HB) or PMMA Plexiglas infra-red light-permeable (UL 94 HB); for efficient infra-red signals the recessed front face is clear polished
- Belt/pocket clip as accessory
- Internal fastening pillars for PCBs

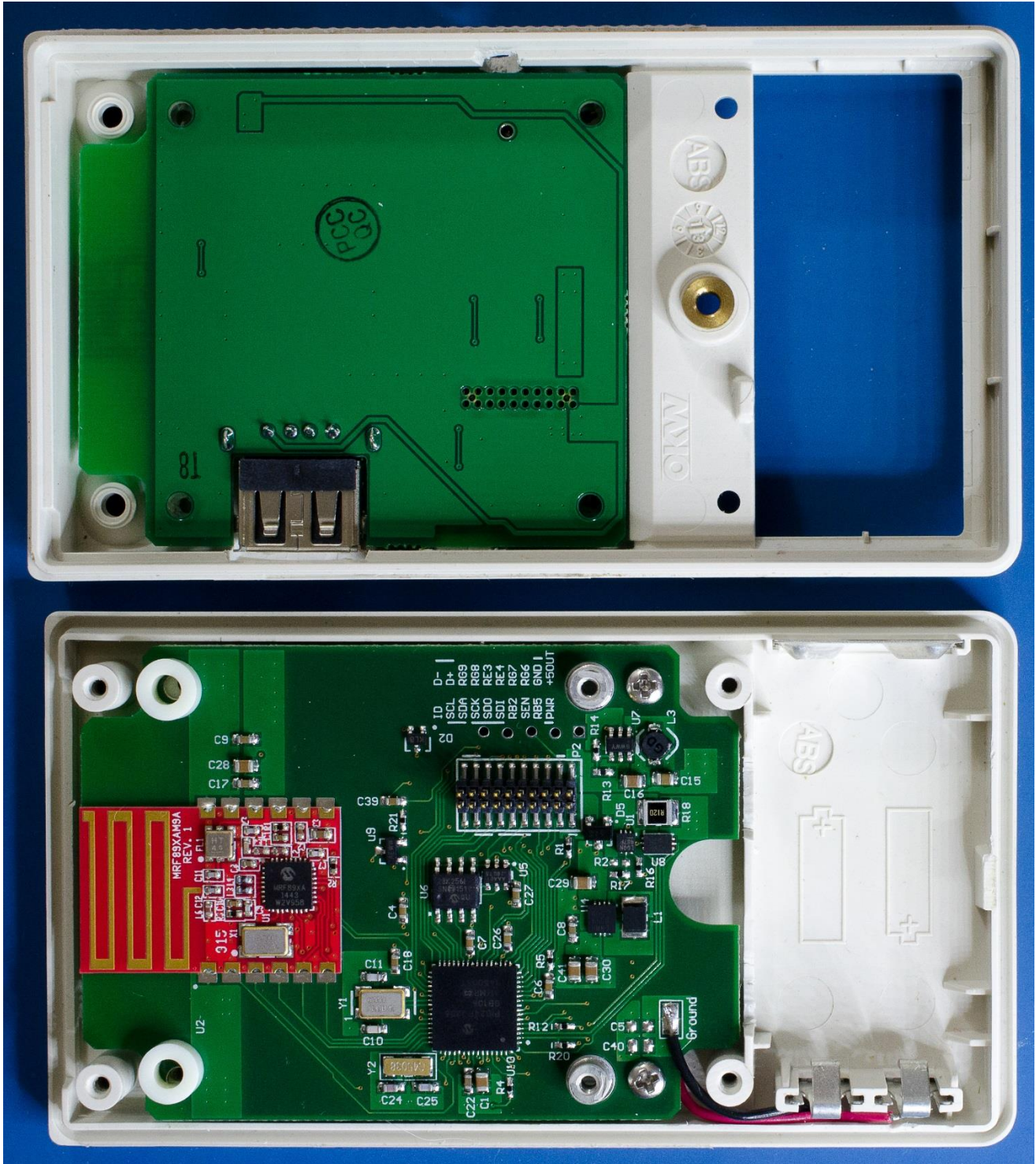
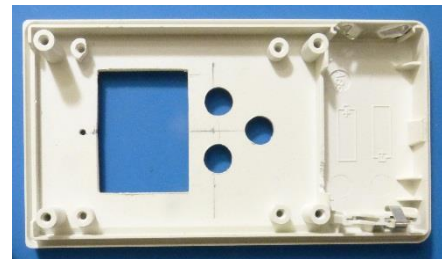

Figure 51 Board placement



*Figure 52. Multiple enclosure views*

## ICD Connection

Observe connector polarity and attach programming cable. Only five connections are used. Pin 6 is not connected. ICD can be configured to supply power while programing.

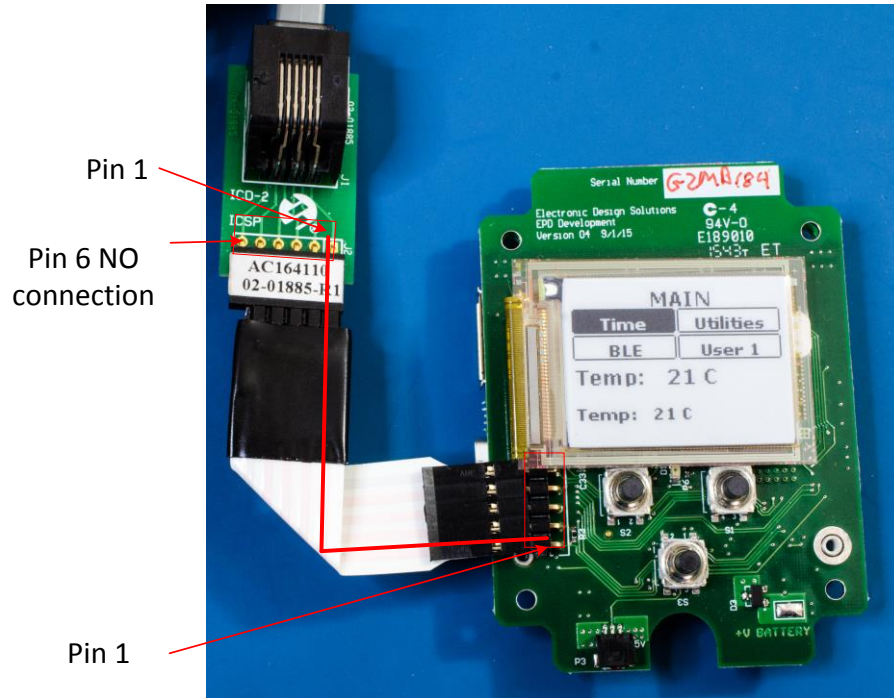

## Known Issues

1. *ICD connection interference with display. Use right angle header. Build ribbon extension. RESOLVED*
2. *User key press missed when display is updating. Add code to process user key press with change notice interrupt.*
3. *Sleep current 100 micro amps, should configure i/o pins to reduce current to 40 micro amps*
4. *Connector P4 footprint placement interferes with the board edge. Three solutions, do not populate; cut the edge of the pcb to allow part to mount properly; cut the component alignment pin so the part sits flat on the board. There is also a mechanical interference between the connector and the enclosure.*

## Overlay

Reference dimensions for overlay common features. Figure 46 shows the overall dimensions to size an overlay to fit the enclosure. Also window placement for the display and status led are dimensioned. The PCB datum is also included for reference common feature elements.

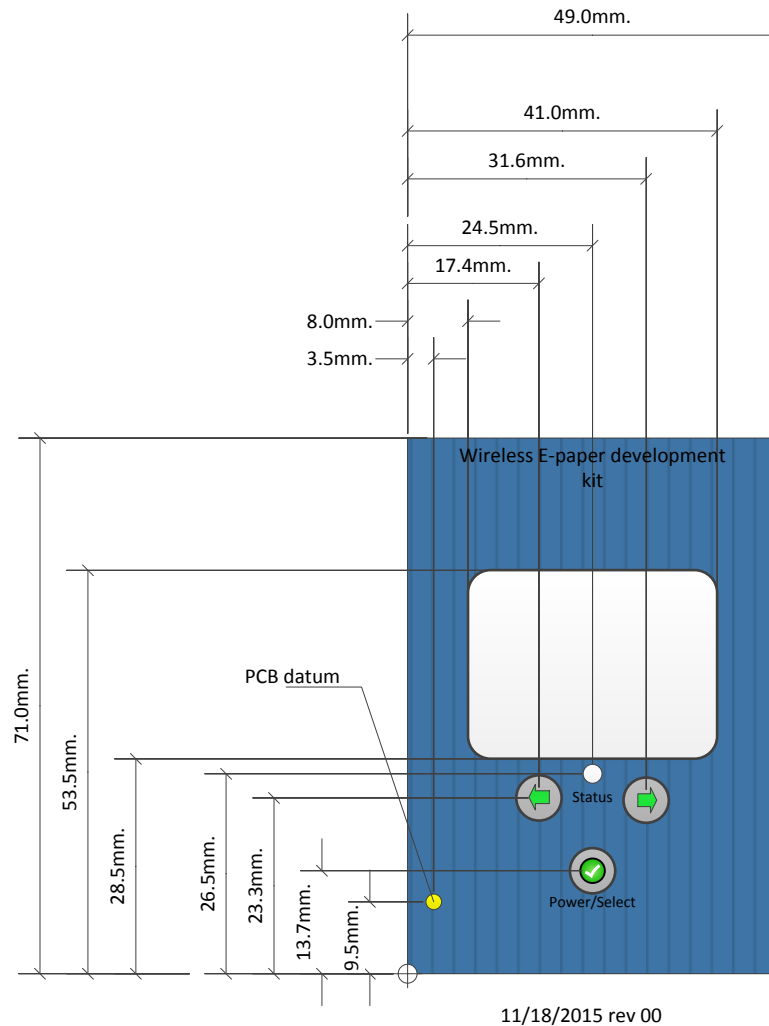
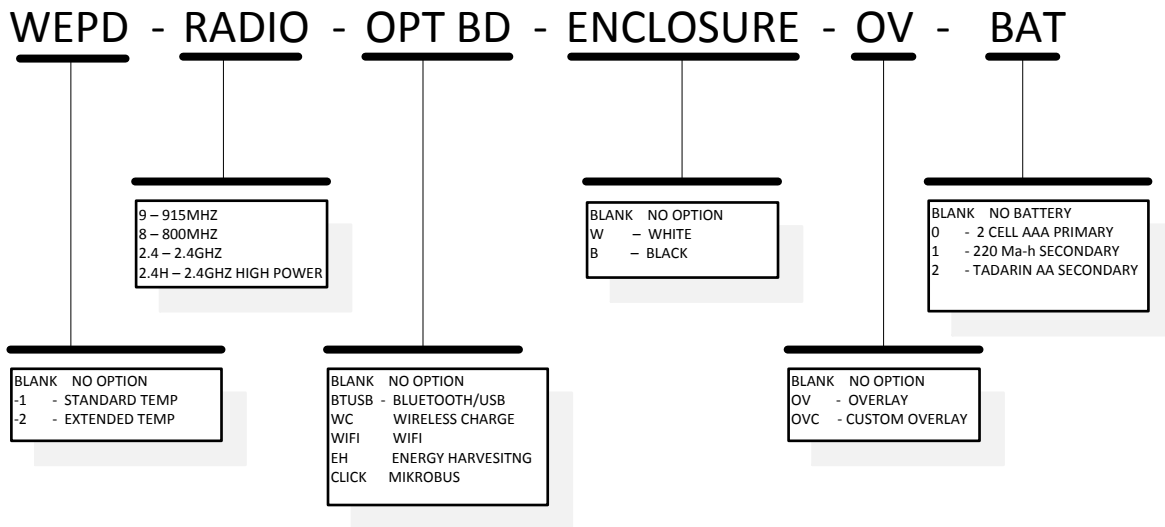

Figure 53. Overlay artwork dimensions



## Ordering Information

### PART NUMBER CONFIGURATION



## Useful links

[www.microchip.com](http://www.microchip.com)

[www.pervasivedisplays.com](http://www.pervasivedisplays.com)

[www.lt.com](http://www.lt.com)

E-Paper RSSI Radio Demo v3 <https://youtu.be/G2NWAZpR4Ws>

E-Paper USB Data Logging Demo v3 <https://youtu.be/2toYaEPBGlg>

E-Paper Bluetooth Low Energy Demo v3 [https://youtu.be/mn-0Y\\_Bd1MI](https://youtu.be/mn-0Y_Bd1MI)

E-Paper Lithium Ion Battery Charger v3 <https://youtu.be/iVlajvmA6cA>

ePaper and MiWi Demo <https://youtu.be/MTZtlvFEuHw>

Add trade mark info for Microchip, Linear Technology and Pervasive Display